



# CREATOR

6910





1

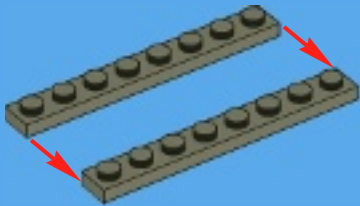

2

2

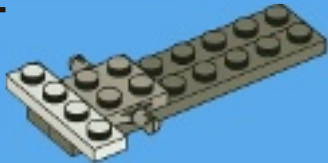

3



4

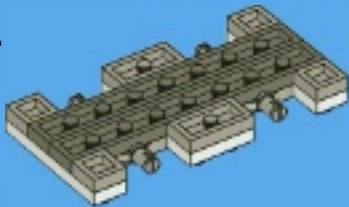

5

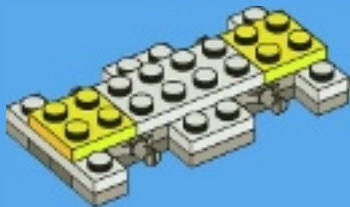

6

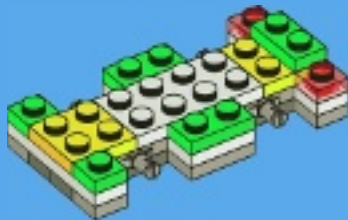

7

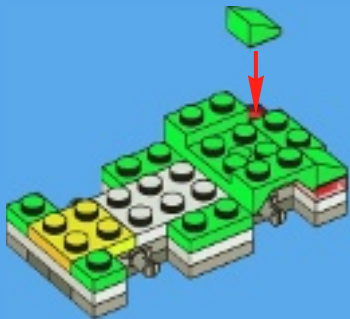

8



9



10

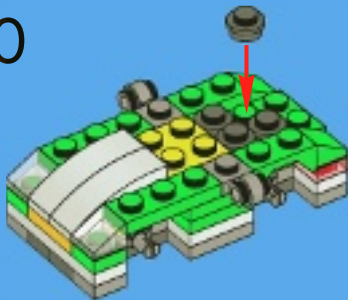

11

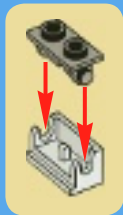
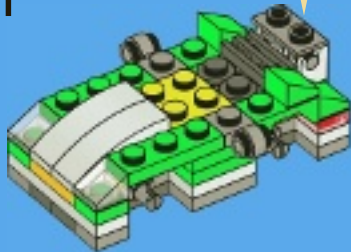

12

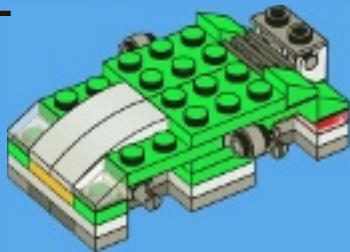

13

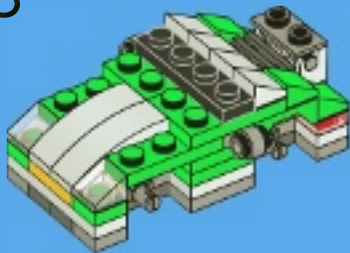

14

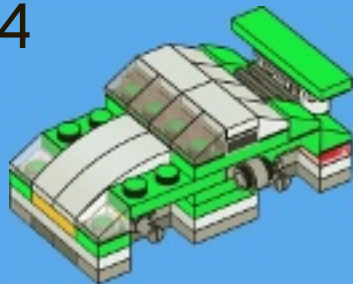



15

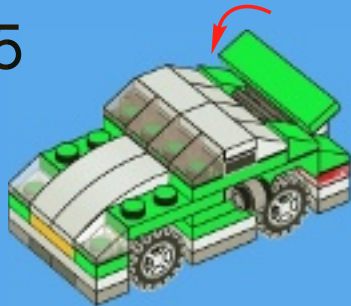



1

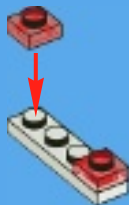

2



3



4

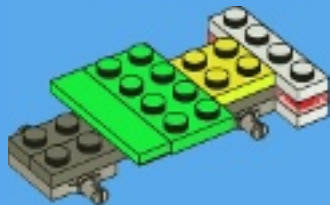

5

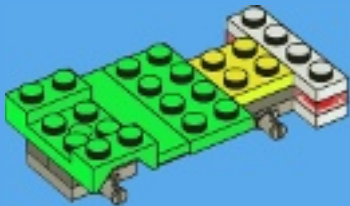

6



7

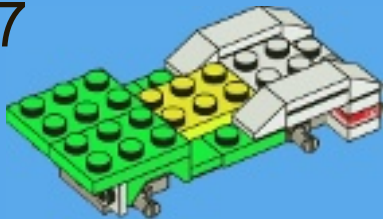

8

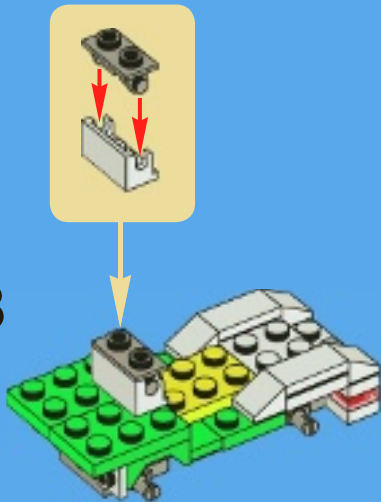

9

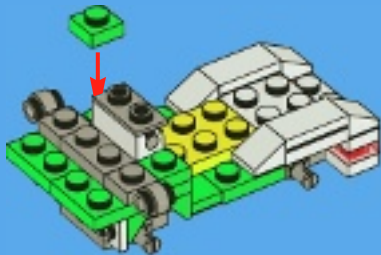

10

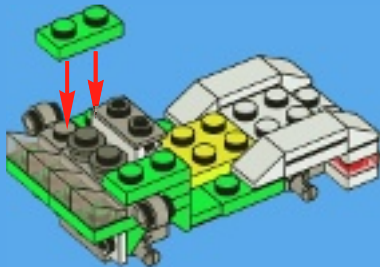

11

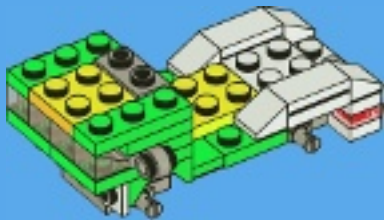

12

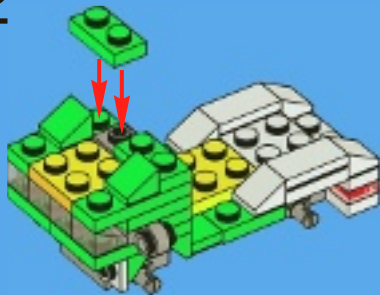

13

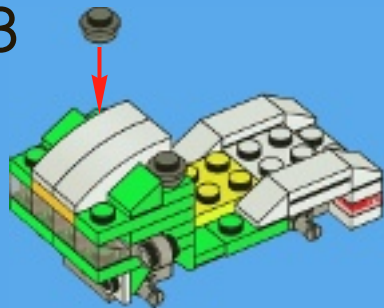

14

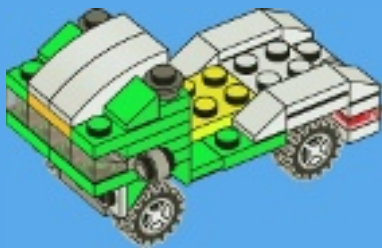



1



2



3



15





1

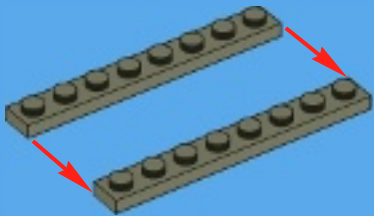

2

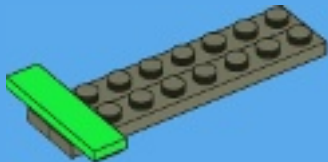

3

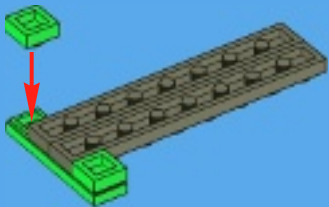

4

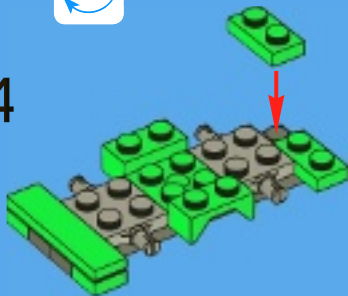

5

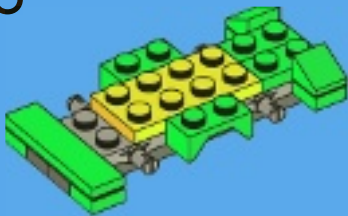

20

1



2

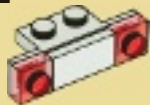

6



7

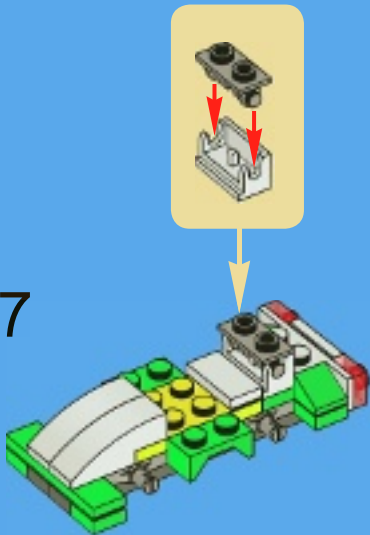

8

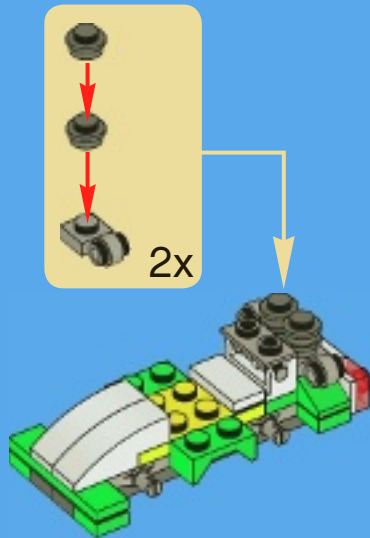

9

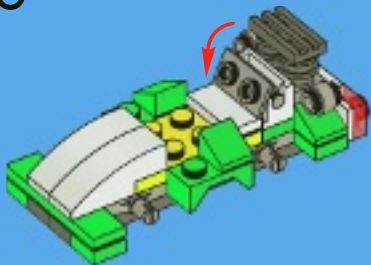

22

10

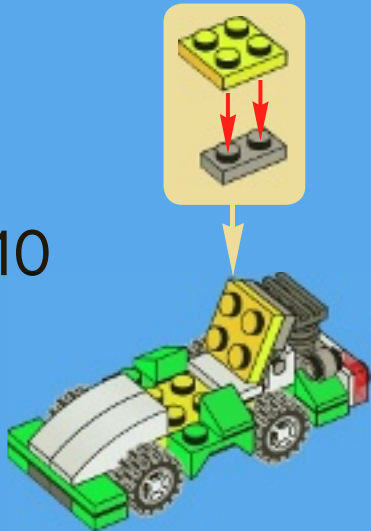



4x  
4504369



2x  
4249112



2x  
306901



2x  
371001



2x  
302001



1x  
4282737



4x  
462401



1x  
393701



3x  
302224



1x  
302024



1x  
371026



4x  
4578677



4x  
4546705



2x  
302428



4x  
302328



2x  
4107758



2x  
302128



1x  
243128



1x  
302028



1x  
4649407



4x  
4244368



2x  
3000841



2x  
4244362



4x  
4211399



2x  
4211398



2x  
4632575



2x  
4211504



1x  
4211470



1x  
4210631



4x  
4210633



2x  
4210998



**Customer Service**

**Kundenservice**

**Service Consommateurs**

**Servicio Al Consumidor**

**www.lego.com/service or dial**



**: 00800 5346 5555**



**: 1-800-422-5346**



# CREATOR

6912



6913



7291



6914



7292



LEGO and the LEGO logo are trademarks of the/sont des marques de commerce de/son marcas registradas de LEGO Group. ©2012 The LEGO Group.

creator.LEGO.com  
4656079 / 4656116



www.LEGO.com

