

The LEGO logo is displayed in its characteristic white, bold, sans-serif font with a thick black outline, set against a solid red rectangular background.

8424



WARNING: CHOKING HAZARD.
Small parts. Not for children under 3 years.

1

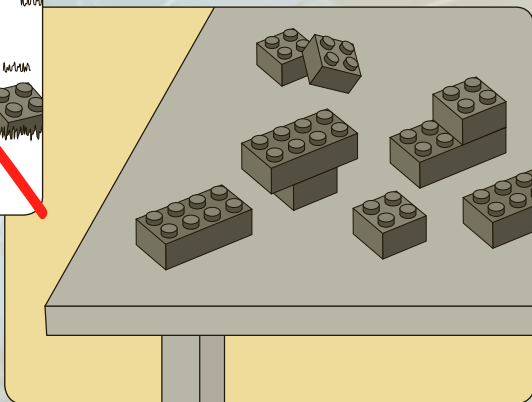
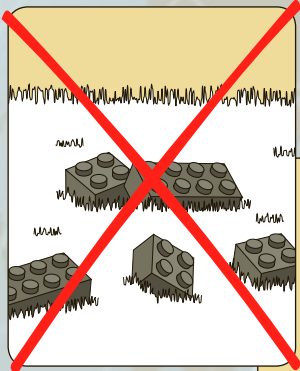

2





1



AVERTISSEMENT : RISQUE D'ÉTOUFFEMENT.
Contient des petites pièces. Ne convient pas aux enfants de moins de 3 ans.



ADVERTENCIA: PELIGRO DE ASFIXIA.
No recomendado para niños menores de 3 años. Contiene piezas pequeñas.

waypoint 1



2



3



4

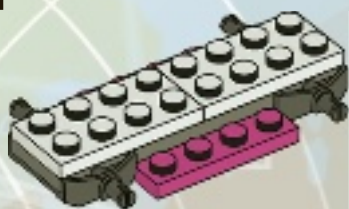

5

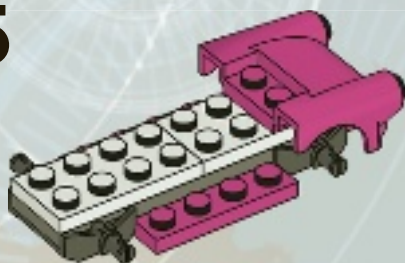

waypoint

7

6

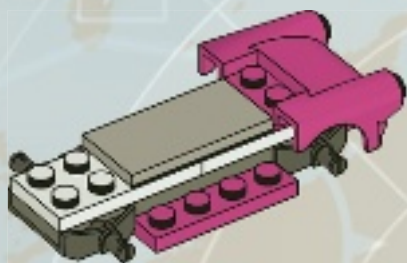

7

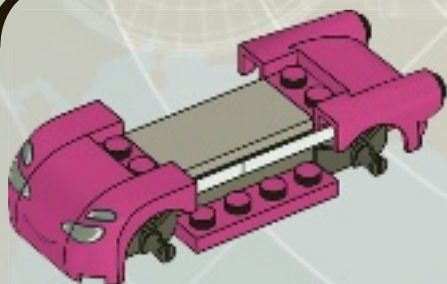

8

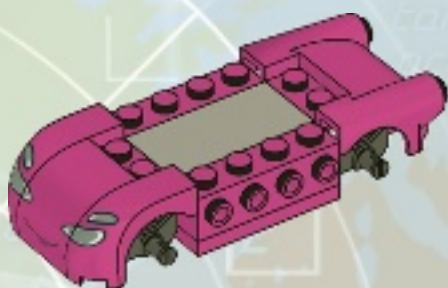

target
acquired

9

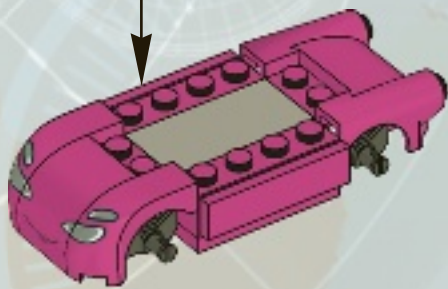
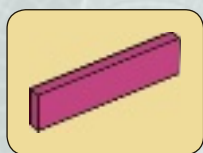

Waypoint

7

10



11



12



13





1

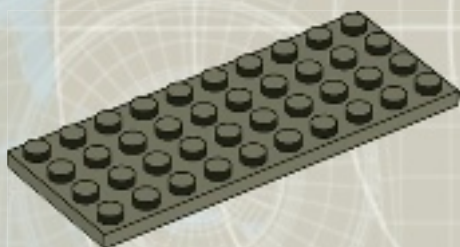

2

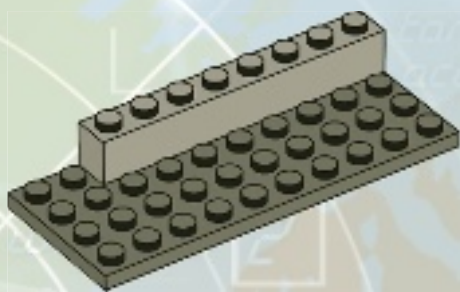

*Target
acquired*

3

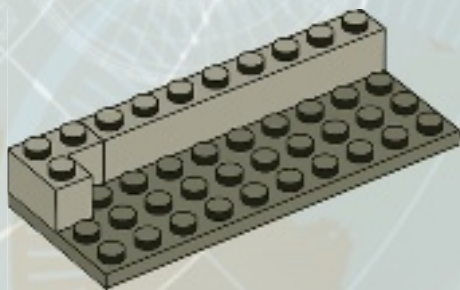

4

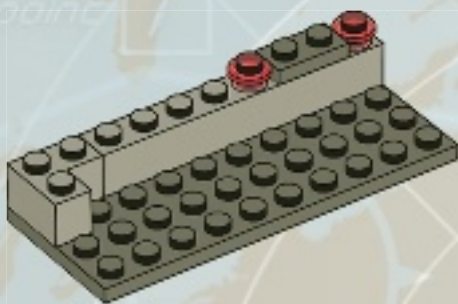

5

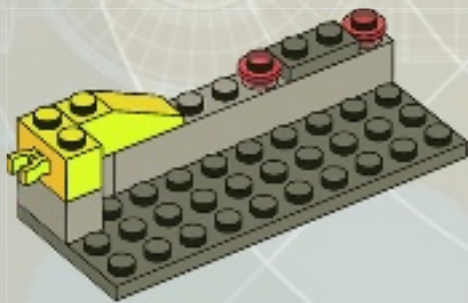

6

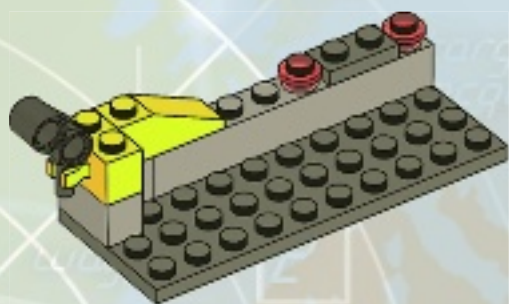

target
required

7

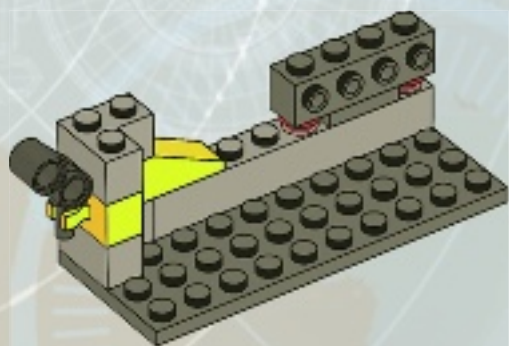

8

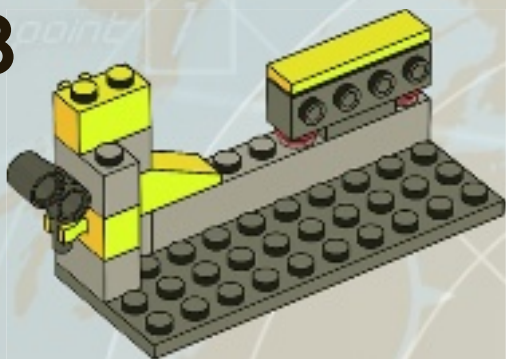

9

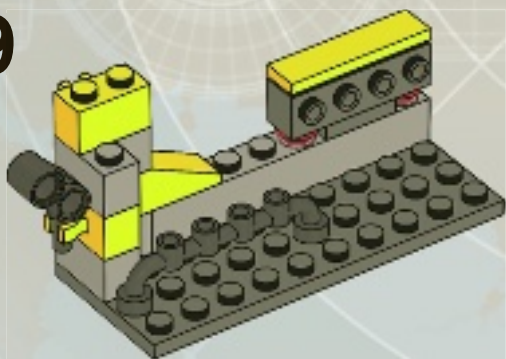

10

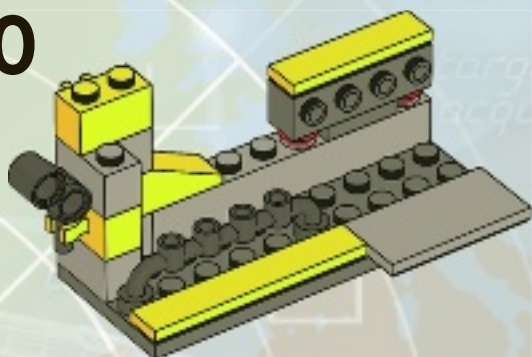

*target
acquired*

11

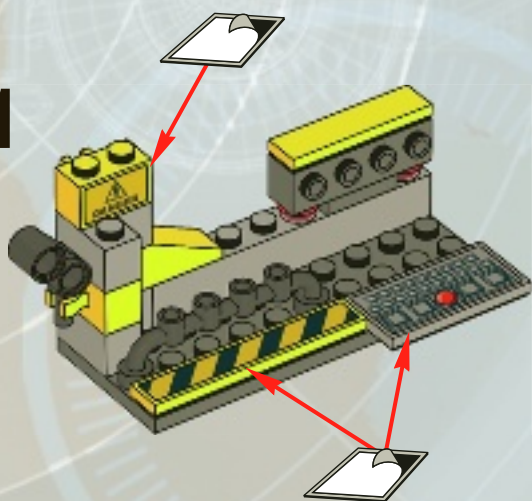

waypoint

1

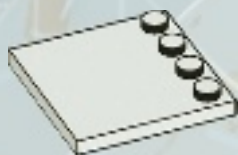

2



3

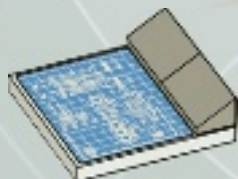

4

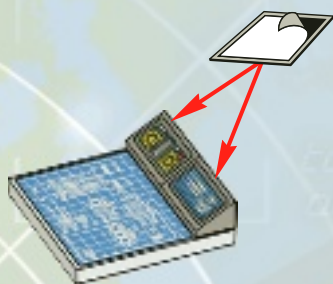

target
acquired

waypoint



12

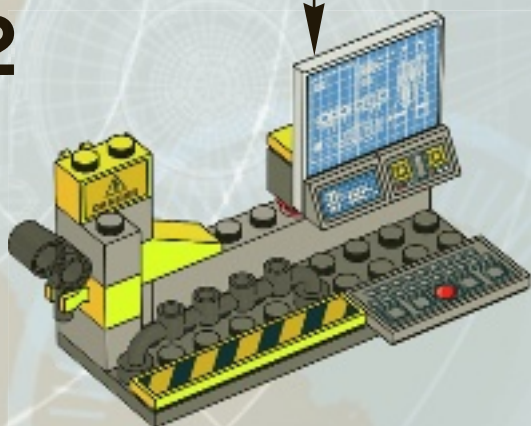

waypoint

7



13



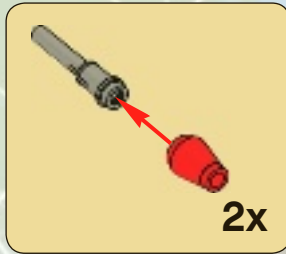

14



1



2



3



4



5



target
acquired

waypoint 2

15

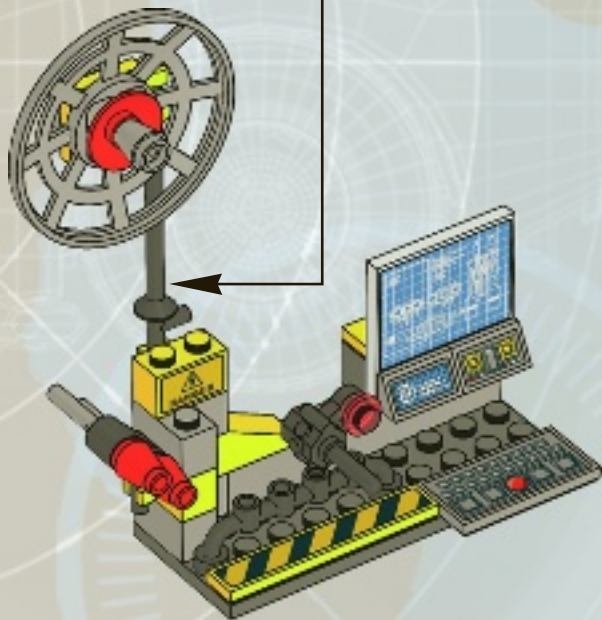



1



2



3

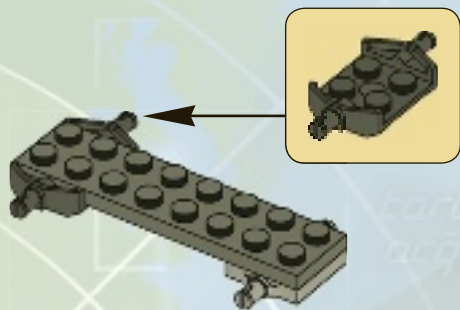

4

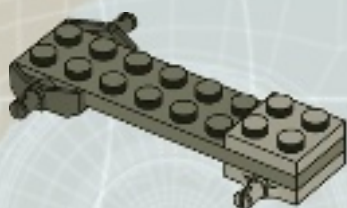

5

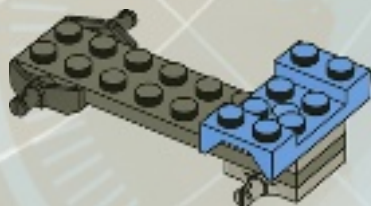

6



7

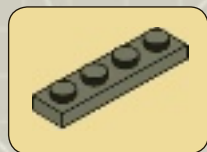

8



target
required

waypoint

9



10



11



12



13

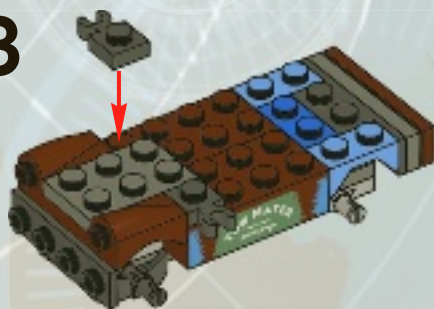

14



15



16



17

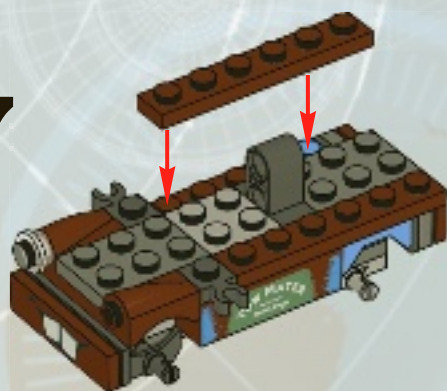

18



19

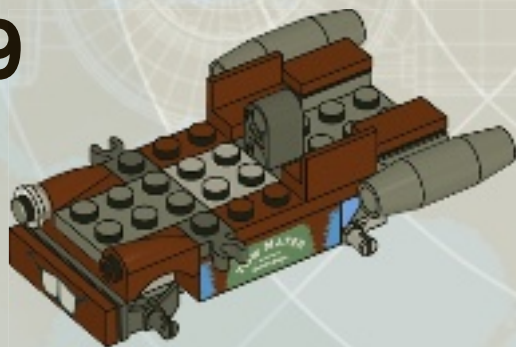

1



2

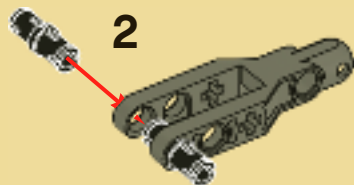

3



4

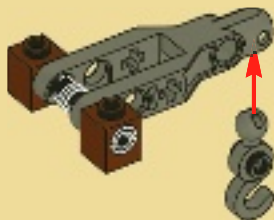

20

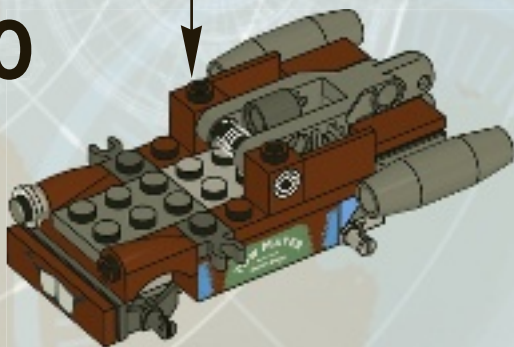

21

Waypoint



22

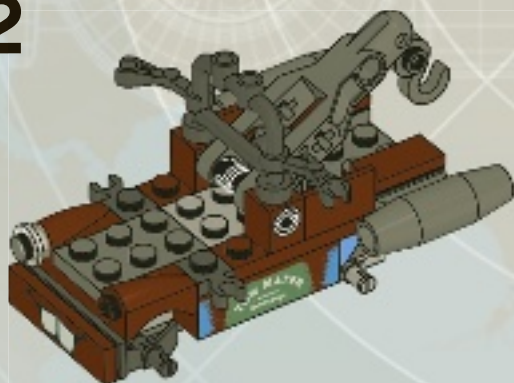

23

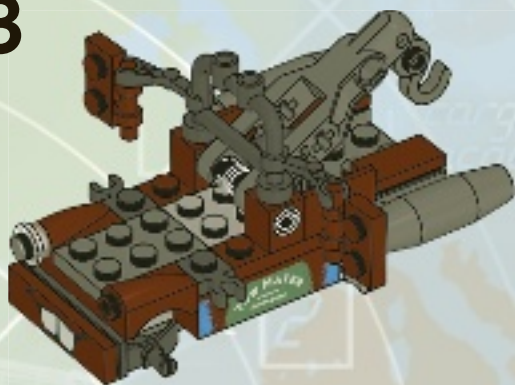

24



waypoint

7

25



target
acquired



26



waypoint

7

27

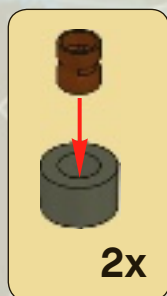

target
acquired



28

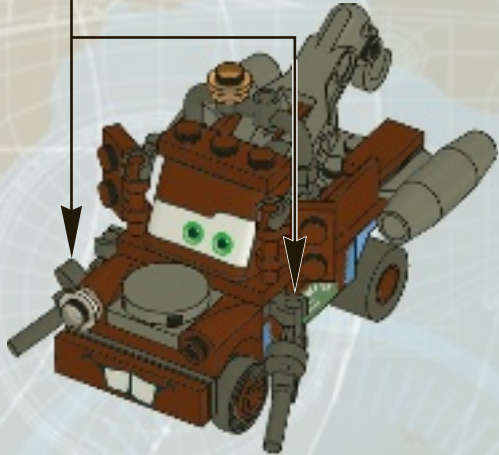

waypoint 7

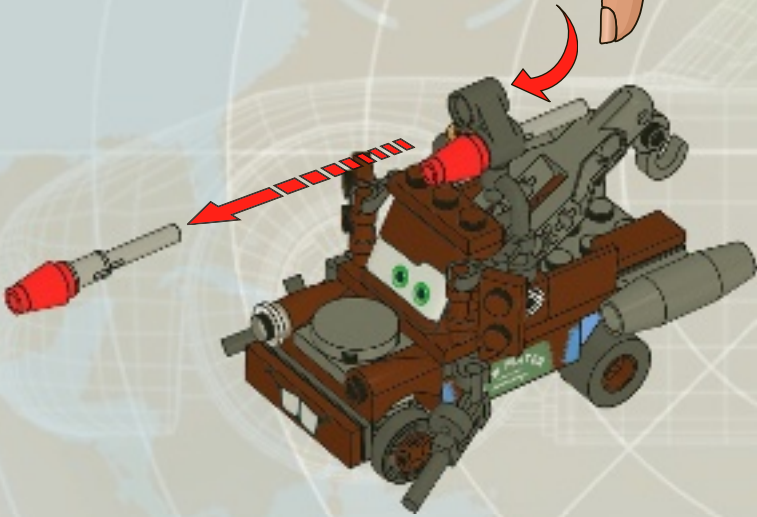





2x
302001



1x
617901



2x
4529234



1x
4585146



2x
302323



2x
4113206



1x
428624



1x
243124



1x
663624



2x
4535740



2x
4550017



1x
4144024



2x
4282746



3x
615726



1x
408326



1x
614026



2x
4223247



1x
4248831



1x
4562148



2x
4549989



1x
384926



4x
4246901



2x
4508215



2x
4516843



2x
4121715



1x
3005740



5x
3005741



1x
4163291



1x
4616698



1x
4621177



2x
4621182



2x
4621180



1x
4243826



1x
4621175



1x
4621184



1x
4222960



2x
4616701



2x
4620075



2x
4211151



1x
4211152

1x
4616707

2x
4211349

4x
4621178

1x
4523398

1x
4620530

1x
4211392

2x
4520320

1x
4210725

2x
4221590

1x
4529241

1x
4211122

1x
4211063

2x
4617030

2x
4568637

2x
4211043

2x
4616702

3x
4211397

2x
4211084

1x
4211001

2x
4620534

2x
4560183

1x
4620079

2x
4620537

1x
4211504

1x
4212529

2x
4210997

1x
4629817

1x
4211480

1x
4613134

1x
4211487

Customer Service

Kundenservice

Service Consommateurs

Servicio Al Consumidor

www.lego.com/service or dial

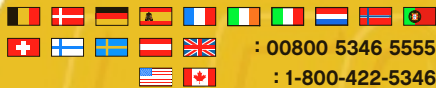

 : 00800 5346 5555

 : 1-800-422-5346



8484



95

8426







8486



8200, 8487



8423, 8639



8638



8639



8424



8639



8638



8426



8201, 8487



8424



8638



8639



8426, 8639



8638



8487



8487



8638



8206



8639



8639



8487



8426



8638



8423



8486



8487



8206, 8484



LEGO.com/CARS





www.LEGOclub.com

LEGO club™

FREE! GRATIS! GRATUIT!



LEGO® Club Magazine



LEGO® Club Email

SIGN UP ONLINE!
www.LEGOclub.com

VISIT THE WORLD'S
BIGGEST LEGO® SHOP!
www.LEGOshop.com

00800 5346 5555



1-866-534-6258 • 1-877-518-5346

USA & Canada only

LEGO.com



* Freephone. Mobile charges may apply. * Numéro sans frais. Des frais peuvent s'appliquer avec les téléphones cellulaires. * Gebührenfrei, Kosten für Anrufe aus Mobilfunknetzen können abweichen. * Gratis telefoonnummer vanaf vaste lijn. * Det er et gratis nummer, når du ringer fra fasttelefon. * Det är gratis, när du ringer från en fast telefon. * Numéro sans frais. Des frais peuvent s'appliquer avec les téléphones portables.

BI112

Go to www.LEGOsurvey.com/product to fill out a survey for a chance to win a cool LEGO® Product.

No purchase necessary.

Open to all residents where not prohibited.

www.LEGOsurvey.com/product

GEWINNE!

Nimm an der Umfrage auf www.LEGOsurvey.com/product teil und hab die Chance ein cooles LEGO® Produkt zu gewinnen!

Die Teilnahme am Gewinnspiel führt zu keinerlei Kaufverpflichtungen. Teilnahme in allen nicht ausgeschlossenen Ländern möglich.

WIN!

Ga naar www.LEGOsurvey.com/product, vul een enquêteformulier in en maak kans op een cool LEGO® product.

Geen aankoopverplichting. Iedereen mag deelnemen, uitgezonderd ingezetenden van landen waar een enquêteverbod geldt.

GAGNE!

Visite www.LEGOsurvey.com/product pour répondre à un questionnaire et avoir une chance de gagner un produit LEGO® très cool!

Aucune obligation d'achat. Ouvert à tous les résidents des pays autorisés.

当てよう!

www.LEGOsurvey.com/product にアクセスして、アンケートにご記入ください。当選者にはレゴ製品を差し上げます。

お買い上げの必要はありません。禁止されていない限り、すべての皆様にご利用いただけます。